

CL020 - MARGHERITA

Dimensioni
Lungh. x Largh. x Alt.
cm



352x220x332 cm

Dimensioni
Lungh. x Largh. x Alt.
cm



702x520 cm

Pavimentazione
Antitrauma
Necessaria



35 Mq
Pav. con HIC 150

Altezza di caduta
cm









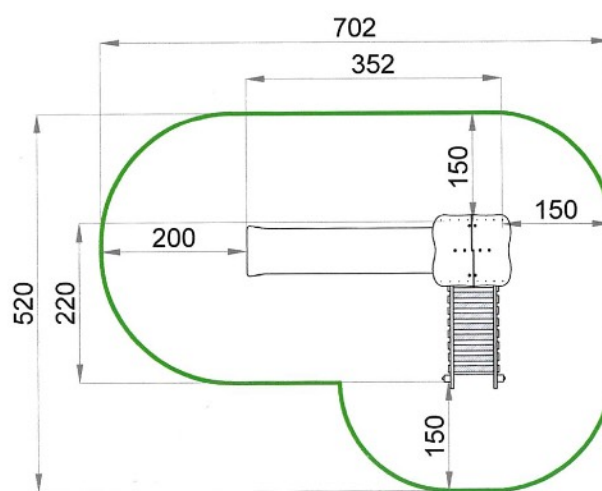



< 150 cm



Struttura realizzata in conformità alle normative UNI-EN 1176:2018



ICONE

ICONE TECNICHE	ICONE SPECIFICHE	ICONE MATERIALE PREDOMINANTE	ICONE FINITURA	
				Finitura Corten
				Finitura Goffrata
				Finitura lucida
